

# Network Management goes 6G

**Wolfgang Kellerer**

SANS 2022 - keynote

Glasgow, Scotland, UK

Dec. 12-13, 2022

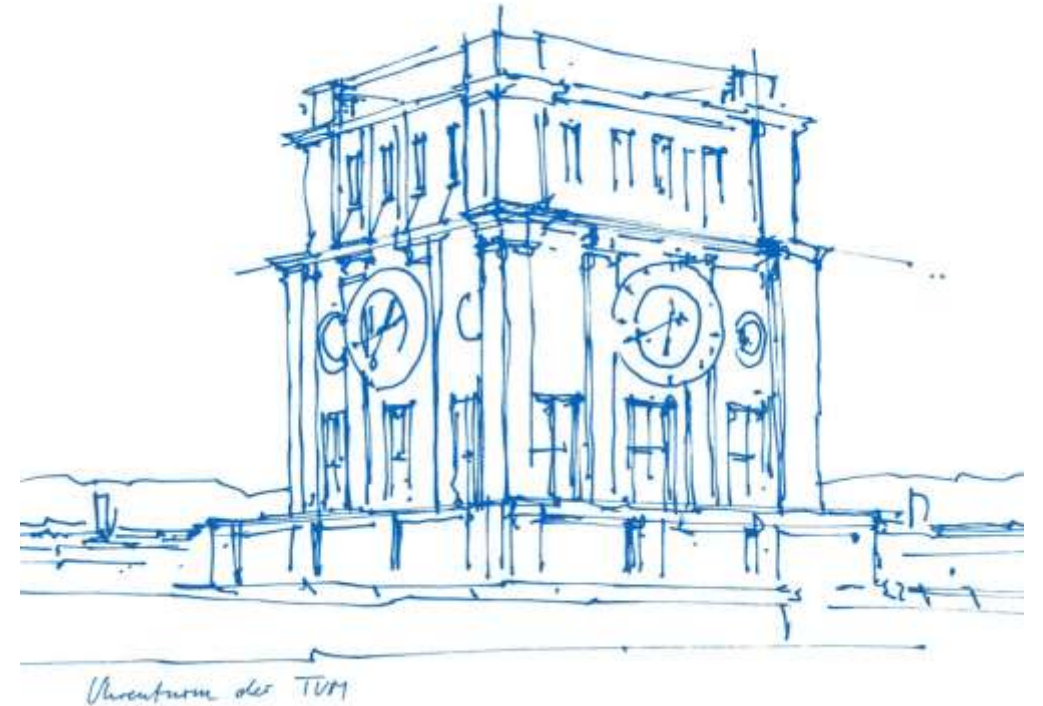

**Rakuten Mobile**

This work receives financial support by the Federal Ministry of Education and Research of Germany (BMBF) in the programme of "Souverän. Digital. Vernetzt." joint project 6G-life, project identification number 16KISK002, and the Bavarian Ministry of Economic Affairs, Regional Development and Energy as part of the project "6G Future Lab Bavaria" and "5G Testbed" and "6G und Quantentechnologie", and the German Research Foundation (DFG), grant number: 316878574.

## „6G will be human focused“

- 4G: mobile apps and video
  - 5G: machine-to-machine communication
  - 6G: the human in the center – extension of the human intelligence and the human abilities
- 
- *for robots collaborating with humans 1ms RTT and 5 nines availability is no longer enough*

# What does this mean for 6G?

- Terahertz-frequency spectrum up to LIFI
- Multi-network (network-of-networks)
- In-network computing
- Network adaptation (communication + processing + storage)
- Network-as-a-Sensor: joint communication and sensing
- AI/ML-native communication
- Sustainability: end-to-end energy efficiency
- Resilience, security, privacy and trust by design
- Beyond paradigms: post-shannon communication, quantum networks, molecular networks

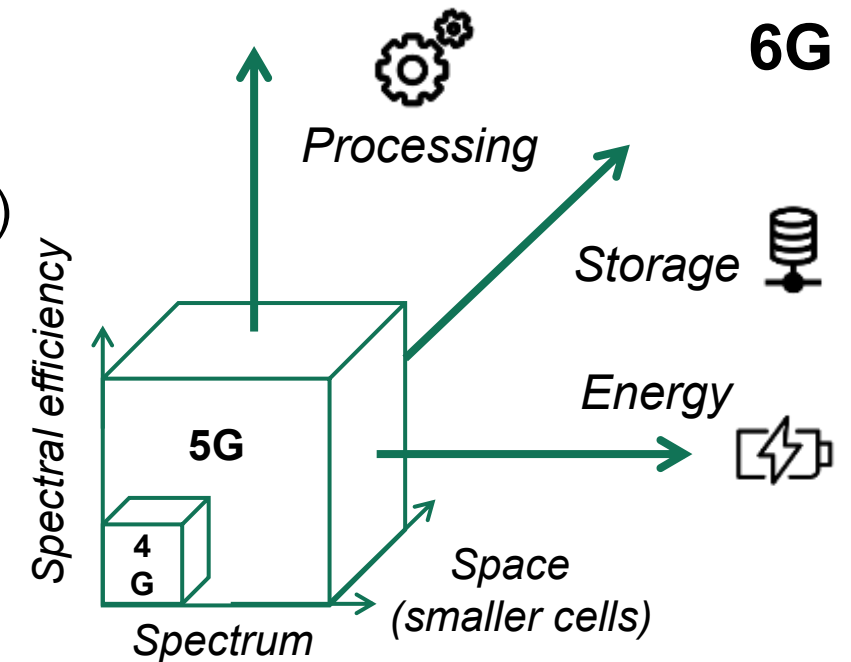

Processing, storage and energy are included in the 6G system optimization

What is in for networking and network management?

# 6G clearly builds on strong future networking concepts

- Terahertz-frequency spectrum up to LIFI
- Multi-network (**network-of-networks**)
- In-network computing
- **Network** adaptation (communication + processing + storage)
- **Network-as-a-Sensor**: joint communication and sensing
- AI/ML-native communication
- Sustainability: end-to-end energy efficiency
- Resilience, security, privacy and trust by design
- Beyond paradigms: post-shannon communication, quantum **networks**, molecular **networks**

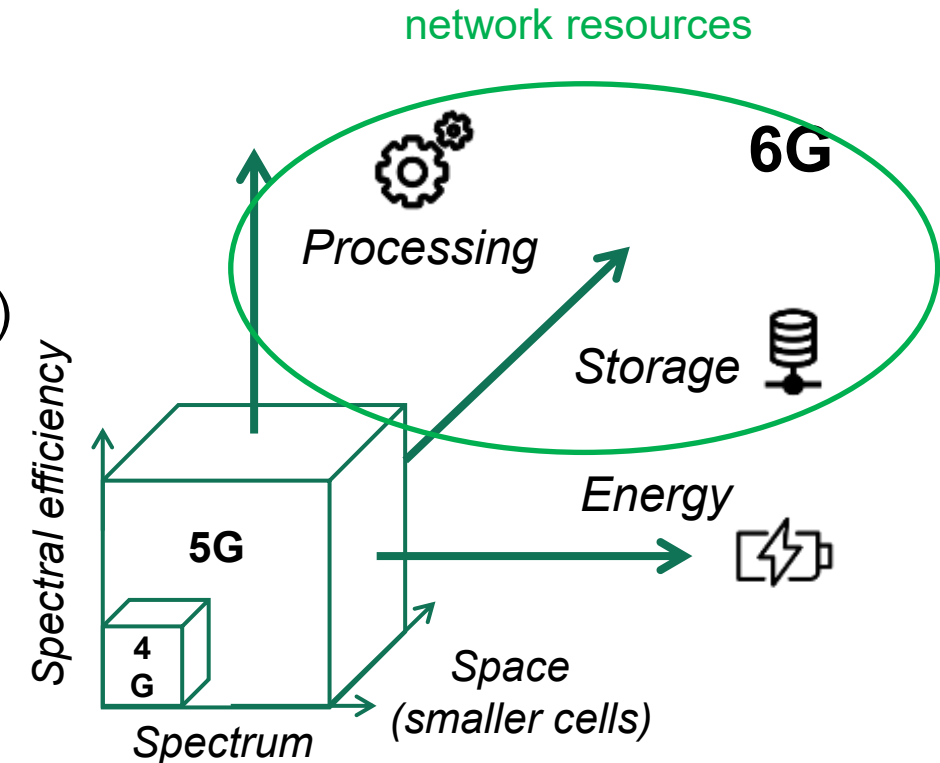

Processing, storage and energy are included in the 6G system optimization

# 6G Experimental Platform



<https://www.5g-munich.de/html/demo.html>

# 5G / 6G Testbed at the Chair of Communication Networks at TUM

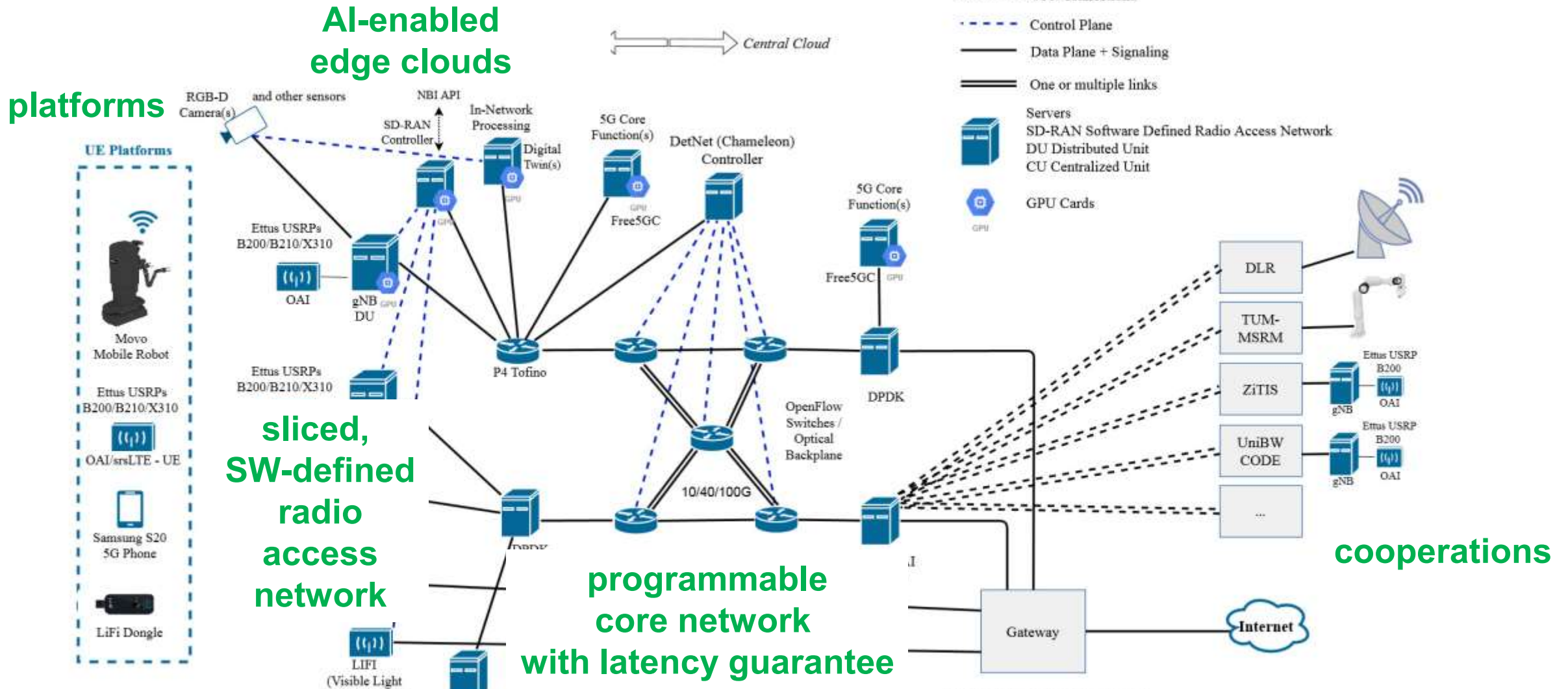

- Van Bemten, Deric, Varasteh, Schmid, Mas Machuca, Blenk, Kellerer: Chameleon: Predictable Latency and High Utilization with Queue-Aware and Adaptive Source Routing. ACM CoNEXT 2020.
- Ayvaşık, Gürsu, Kellerer: Veni Vidi Dixi: Reliable Wireless Communication with Depth Images. ACM CoNEXT 2019.
- Papa, Jano, Ayvaşık, Ayan, Gürsu, Kellerer: User-Based Quality of Service Aware Multi-Cell Radio Access Network Slicing. IEEE Transactions on Network and Service Management, 2021.
- Martínez Alba, Janardhanan, Kellerer: Enabling dynamically centralized RAN architectures in 5G and beyond. IEEE Transactions on Network and Service Management, 2021.
- Papa, Durner, Goratti, Rasheed, Kellerer: Controlling Next-Generation Software-Defined RANs. IEEE Communications Magazine, 2020.
- Goshi, Jarschel, Pries, He, Kellerer: Investigating Inter-NF Dependencies in Cloud-Native 5G Core Networks. 17th International Conference on Network and Service Management (CNSM 2021)

# 5G / 6G Testbed at the Chair of Communication Networks at TUM

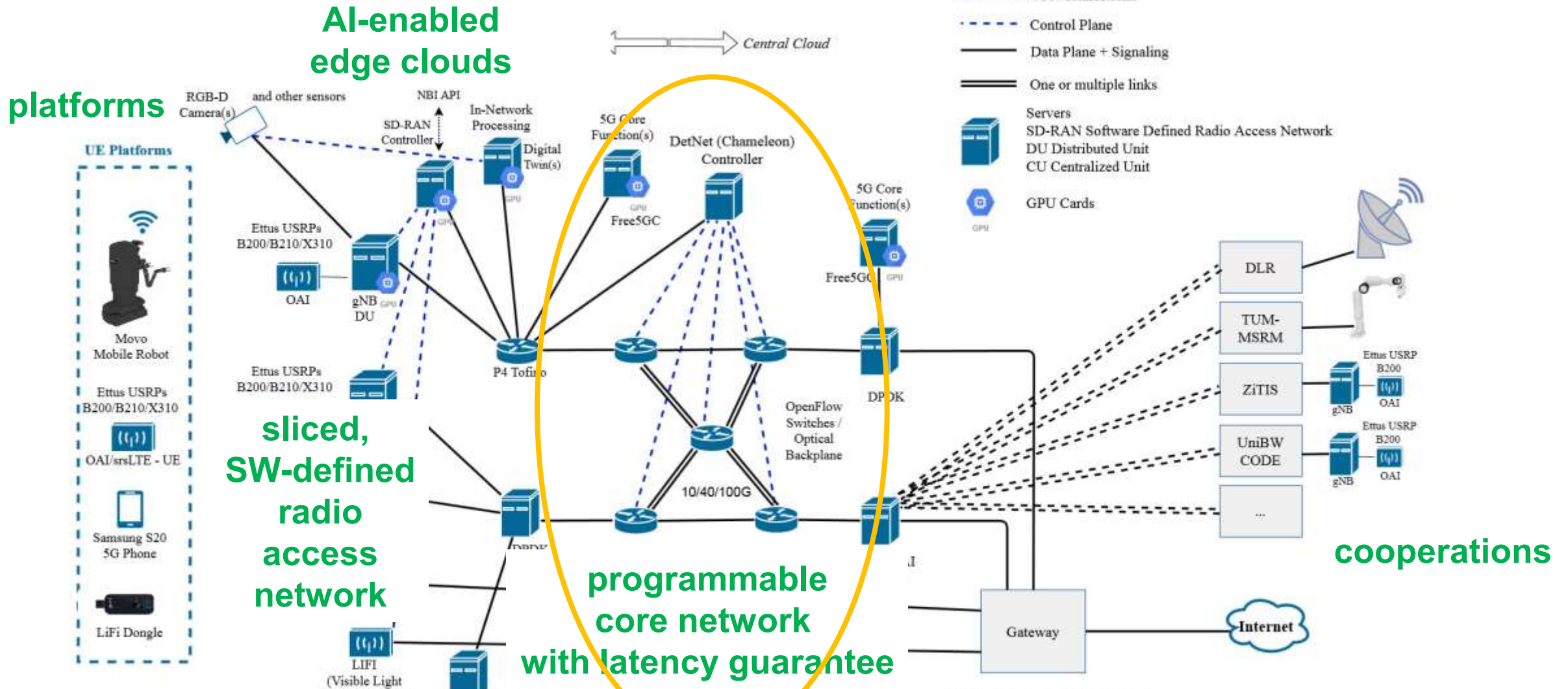

- Van Bemten, Deric, Varasteh, Schmid, Mas Machuca, Blenk, Kellerer: Chameleon: Predictable Latency and High Utilization with Queue-Aware and Adaptive Source Routing. ACM CoNEXT 2020.
- Ayvaşık, Gürsu, Kellerer: Veni Vidi Dixi: Reliable Wireless Communication with Depth Images. ACM CoNEXT 2019.
- Papa, Jano, Ayvaşık, Ayan, Gürsu, Kellerer: User-Based Quality of Service Aware Multi-Cell Radio Access Network Slicing. IEEE Transactions on Network and Service Management, 2021.
- Martínez Alba, Janardhanan, Kellerer: Enabling dynamically centralized RAN architectures in 5G and beyond. IEEE Transactions on Network and Service Management, 2021.
- Papa, Durner, Goratti, Rasheed, Kellerer: Controlling Next-Generation Software-Defined RANs. IEEE Communications Magazine, 2020.
- Goshi, Jarschel, Pries, He, Kellerer: Investigating Inter-NF Dependencies in Cloud-Native 5G Core Networks. 17th International Conference on Network and Service Management (CNSM 2021)



# Chameleon: Guaranteed end-to-end low latency in the network

- Principle:

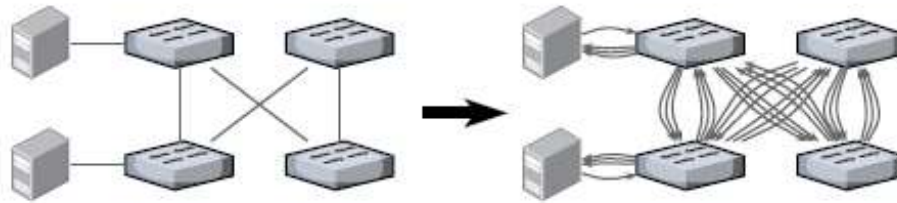

and

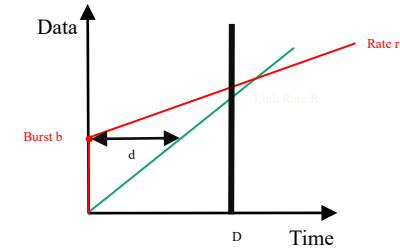

- Realization in a programmable network with central controller: „Chameleon“

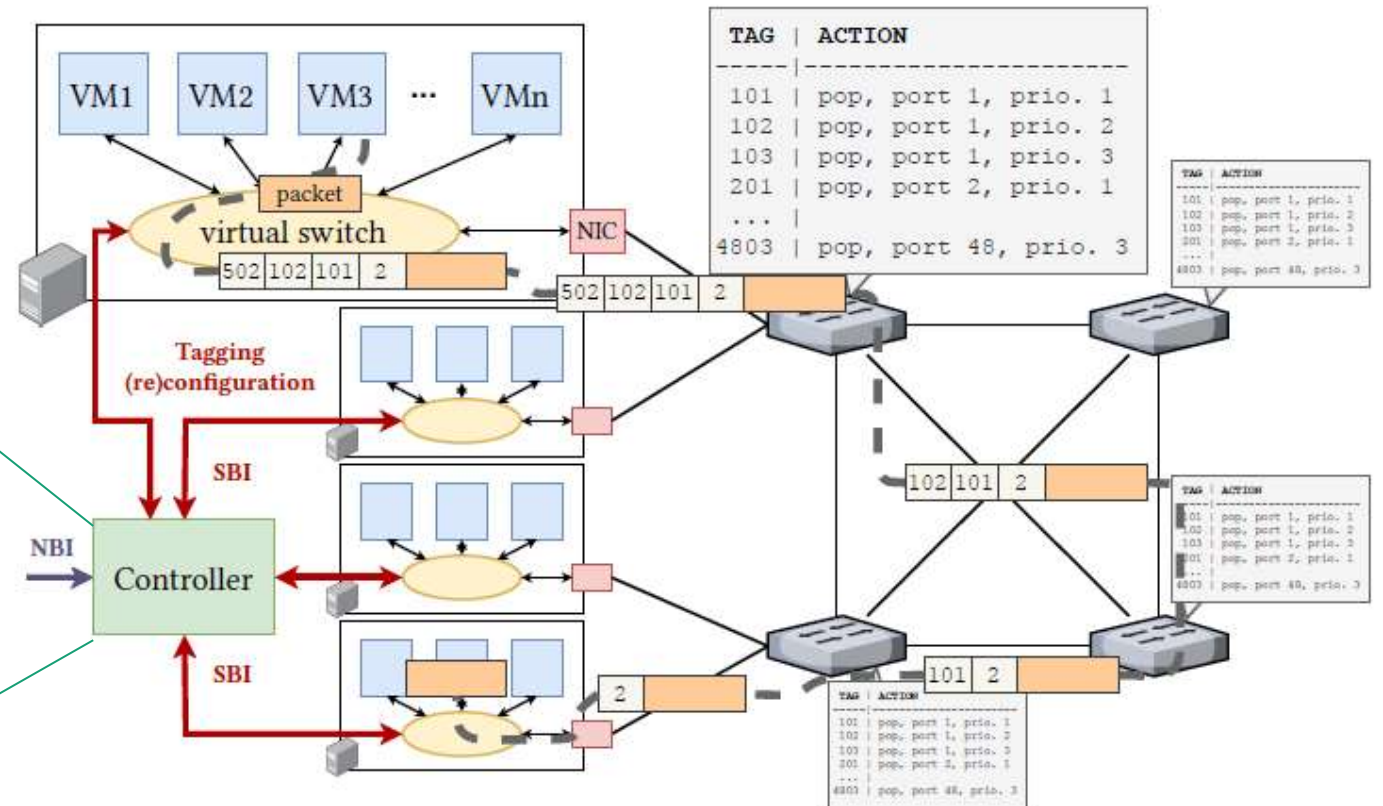
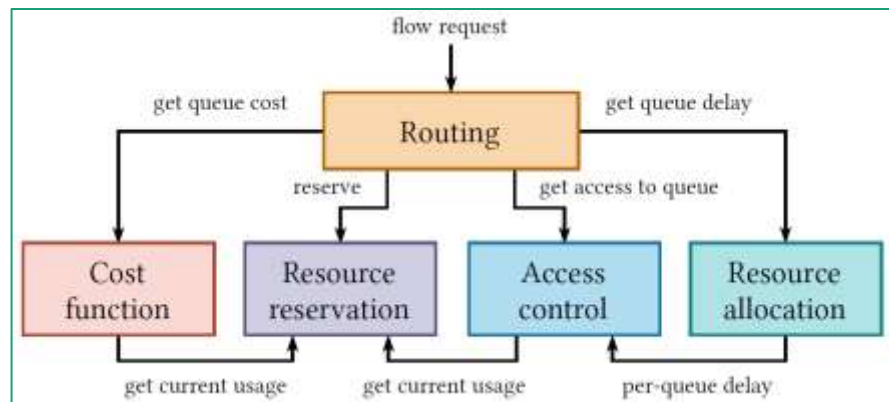

# Chameleon: Guaranteed end-to-end low latency in the network

- Chameleon successfully provides latency guarantees, reaches higher network utilization than existing approaches, and scales to networks with tens of thousands of servers

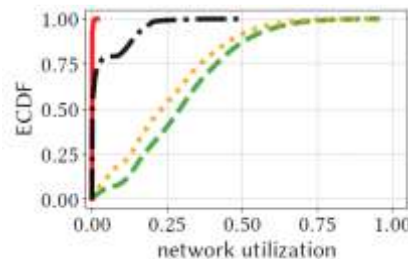
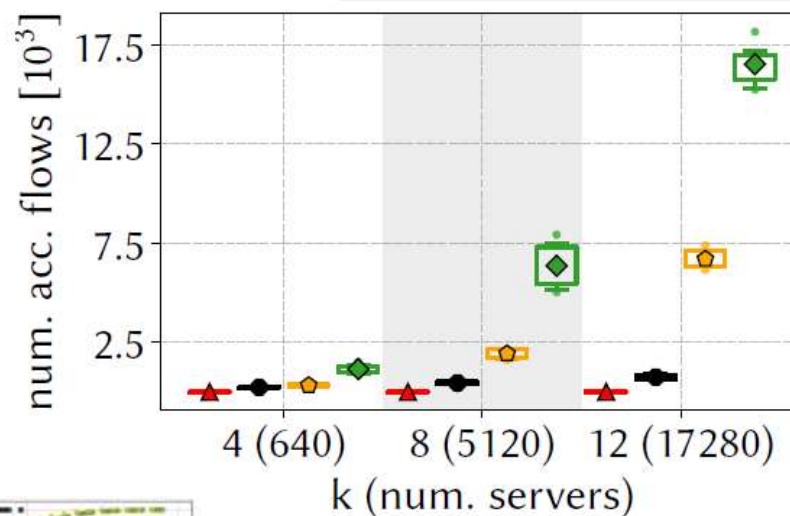
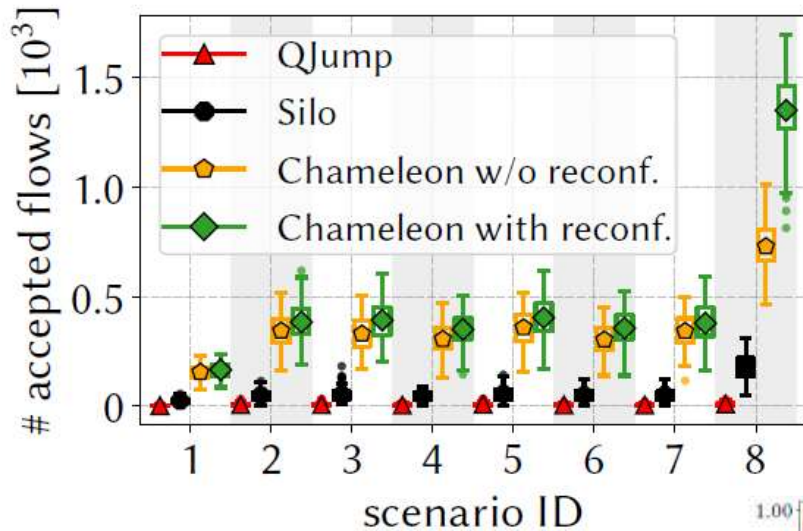

- 30% Industrial
- 30% Clock sync
- 30% Control plane sync
- 10% High Bandwidth

# ... supported by in-network computing and network programmability

- there is no free lunch
- from our research on „quantifying flexibility in communication networks“ (ERC Consolidator Grant FlexNets: 2015 - 2021) → *Consider the Cost of Flexibility!*



✦ The **total operating cost**  $Q = K + C^P + C^R$  of a flexible network is the sum of:

- **Readiness cost**  $K$ : cost of operating the network at the current state given an active demand
- **Proaction cost**  $C^P$ : cost of finding a new state during the proaction phase
- **Reaction cost**  $C^R$ : cost of implementing a new state during the reaction phase

e.g. run control plane and some embedded flows

e.g. run optimizer for new flow embedding

e.g. send control msg. to embedd new flow

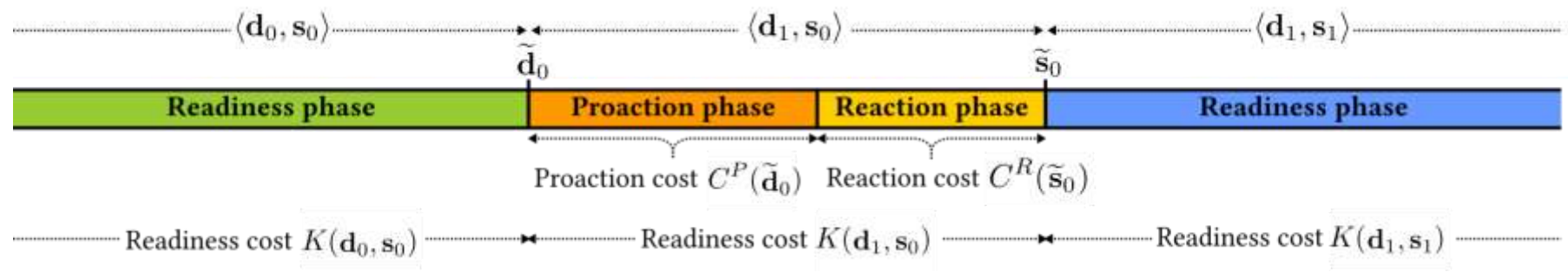

# Example: dynamic flow allocation in SDN network

- **Service:** provide a connection between two nodes when demanded
- **Objective:** minimize number of used links

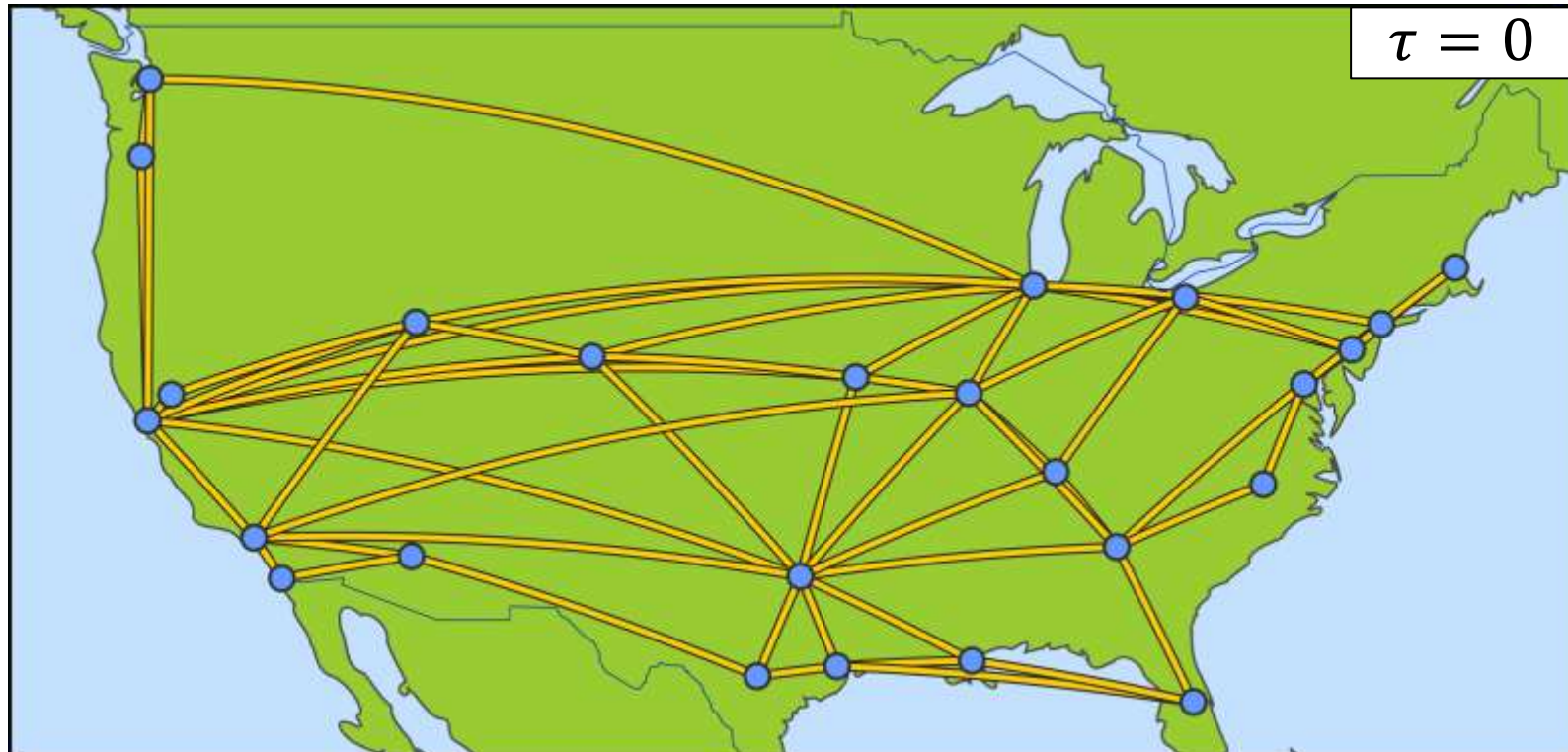

# Example: dynamic flow allocation in SDN network

- **Service:** provide a connection between two nodes when demanded
- **Objective:** minimize number of used links

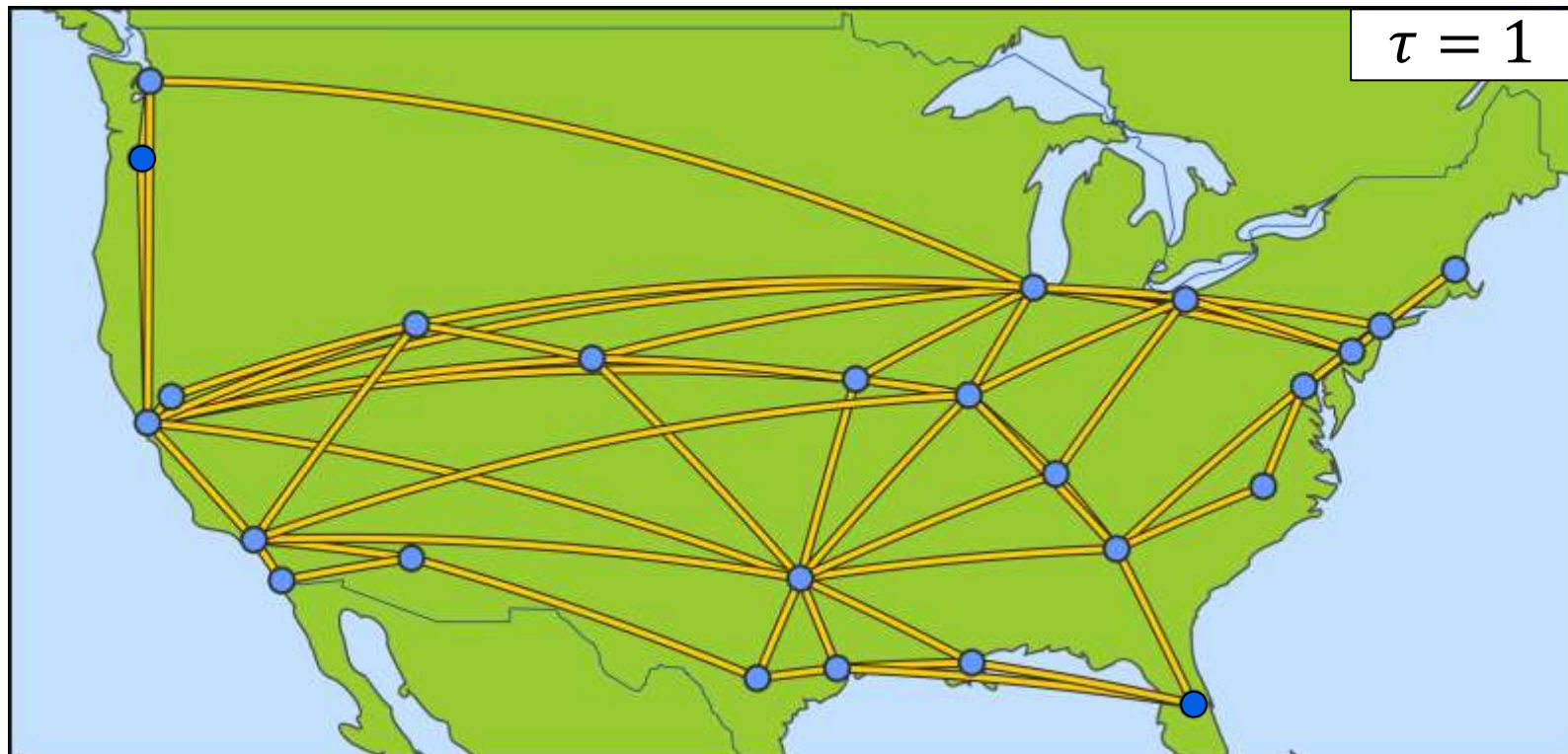

# Example: dynamic flow allocation in SDN network

- **Service:** provide a connection between two nodes when demanded
- **Objective:** minimize number of used links

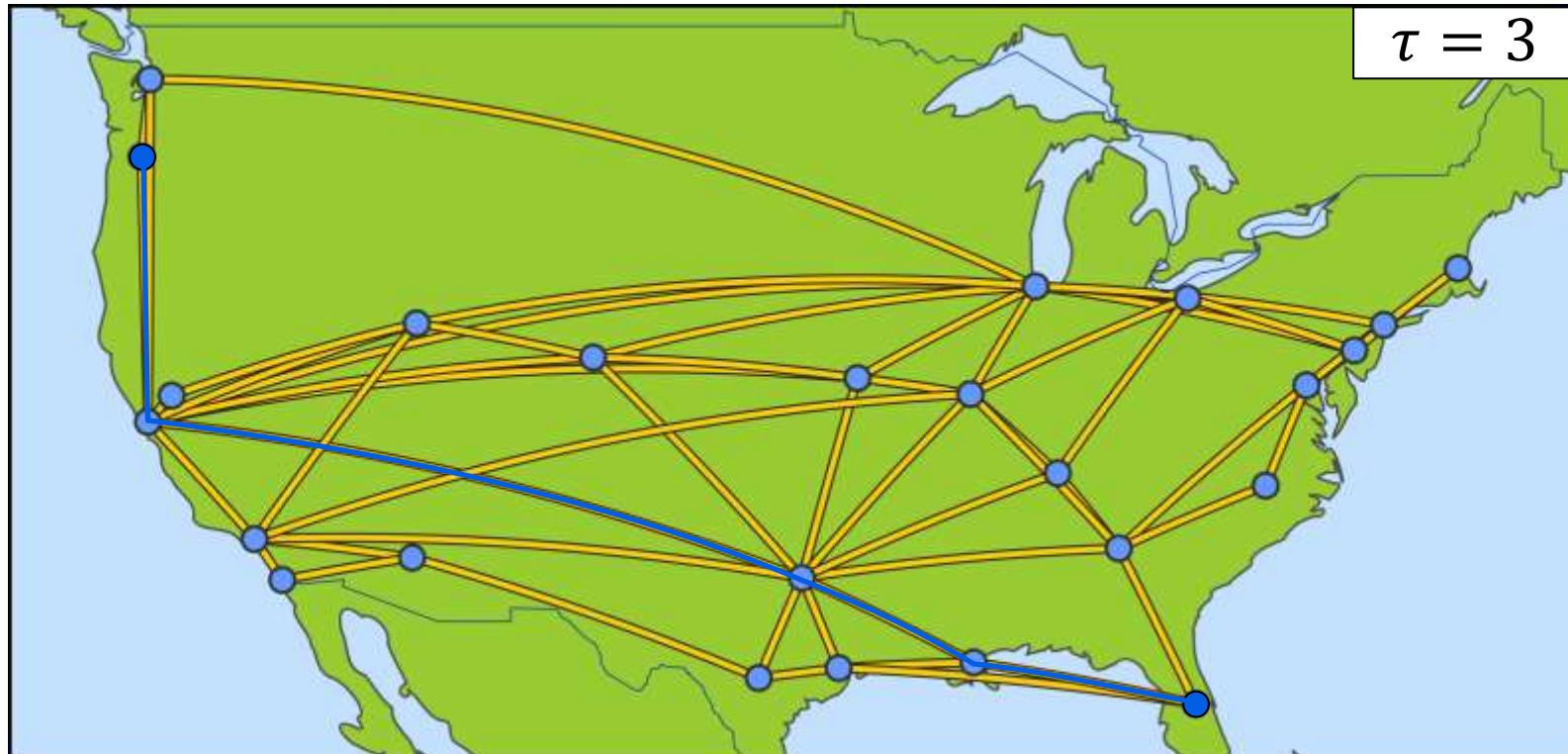

# Example: dynamic flow allocation in SDN network

- **Service:** provide a connection between two nodes when demanded
- **Objective:** minimize number of used links

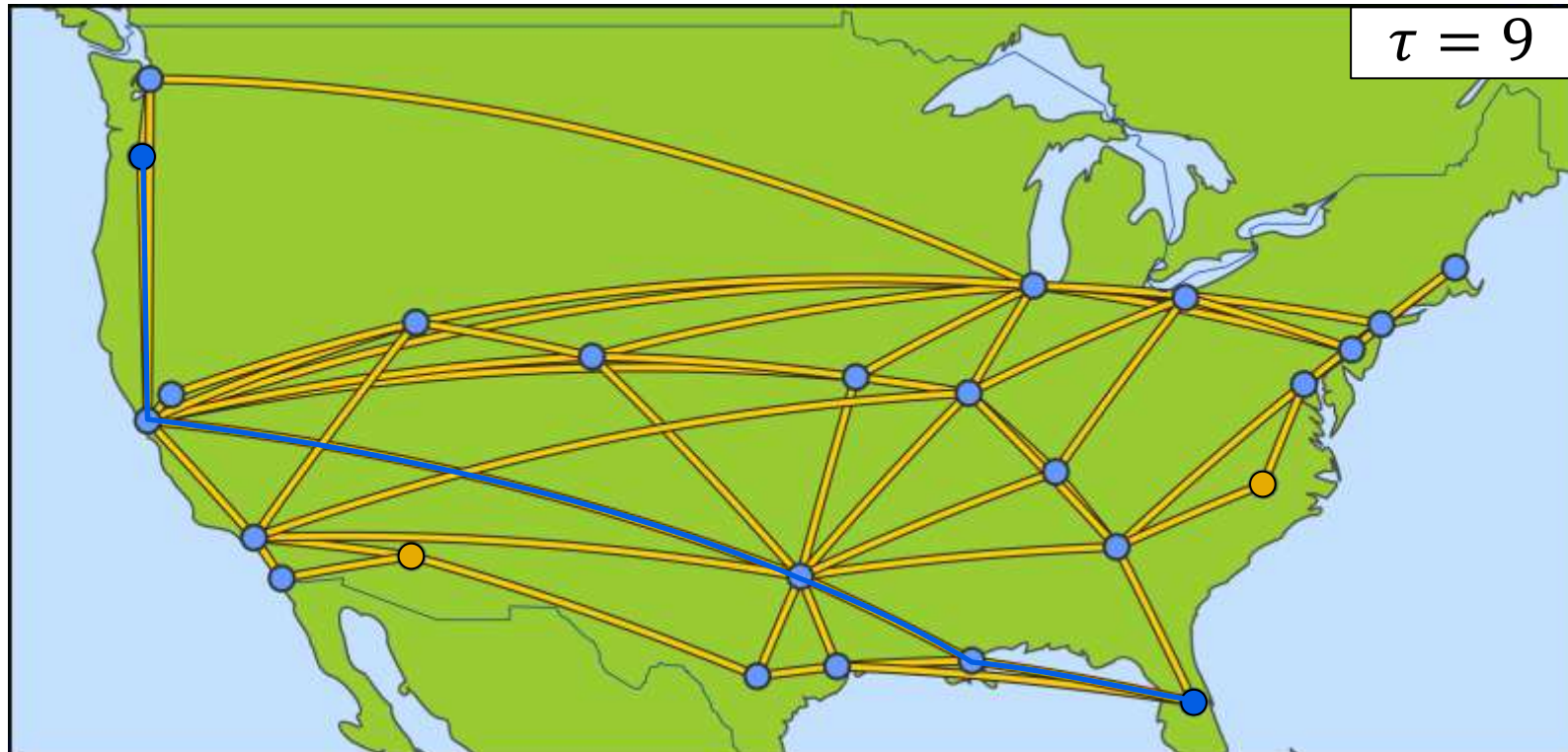

# Example: dynamic flow allocation in SDN network

- **Service:** provide a connection between two nodes when demanded
- **Objective:** minimize number of used links

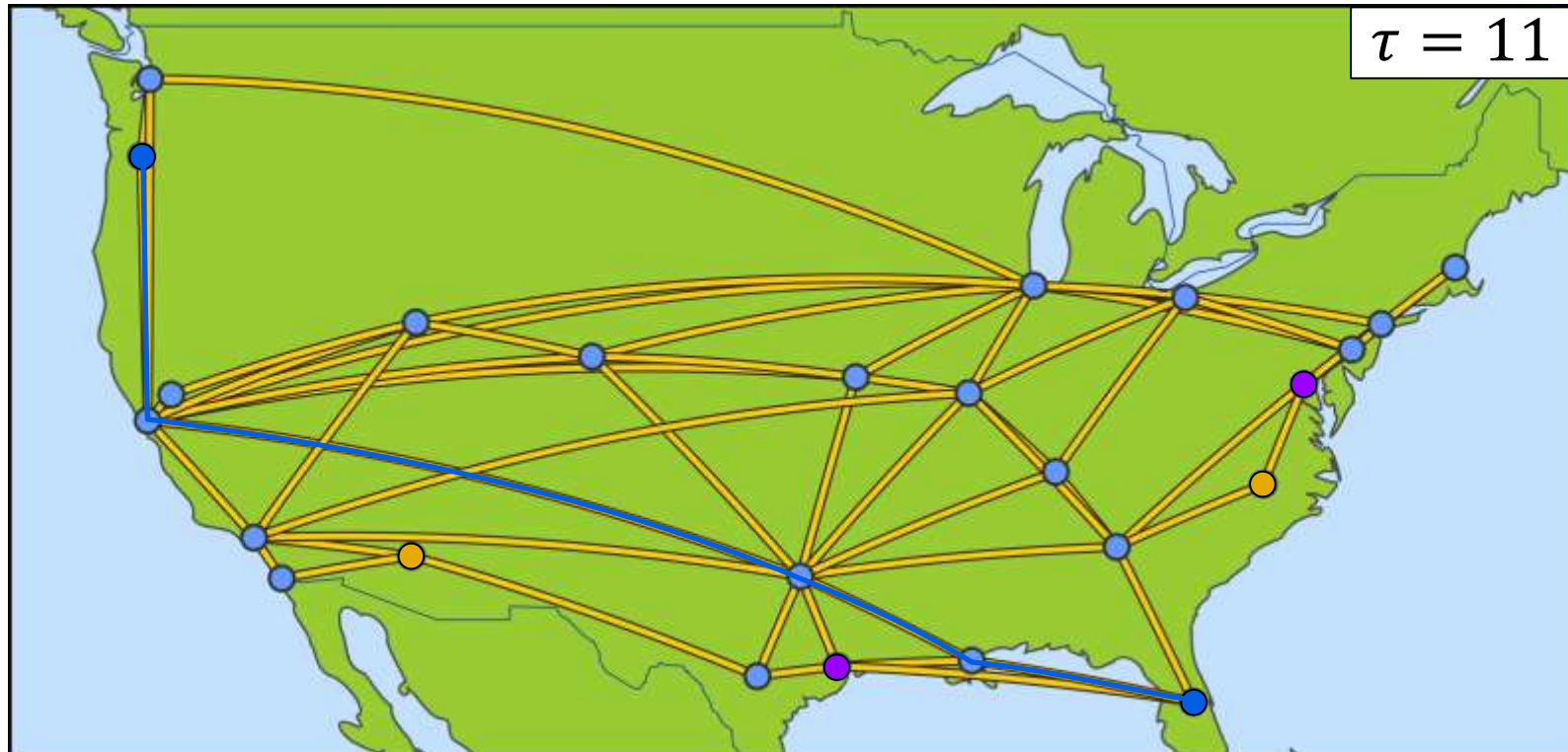



# Example: dynamic flow allocation in SDN network

- **Service:** provide a connection between two nodes when demanded
- **Objective:** minimize number of used links

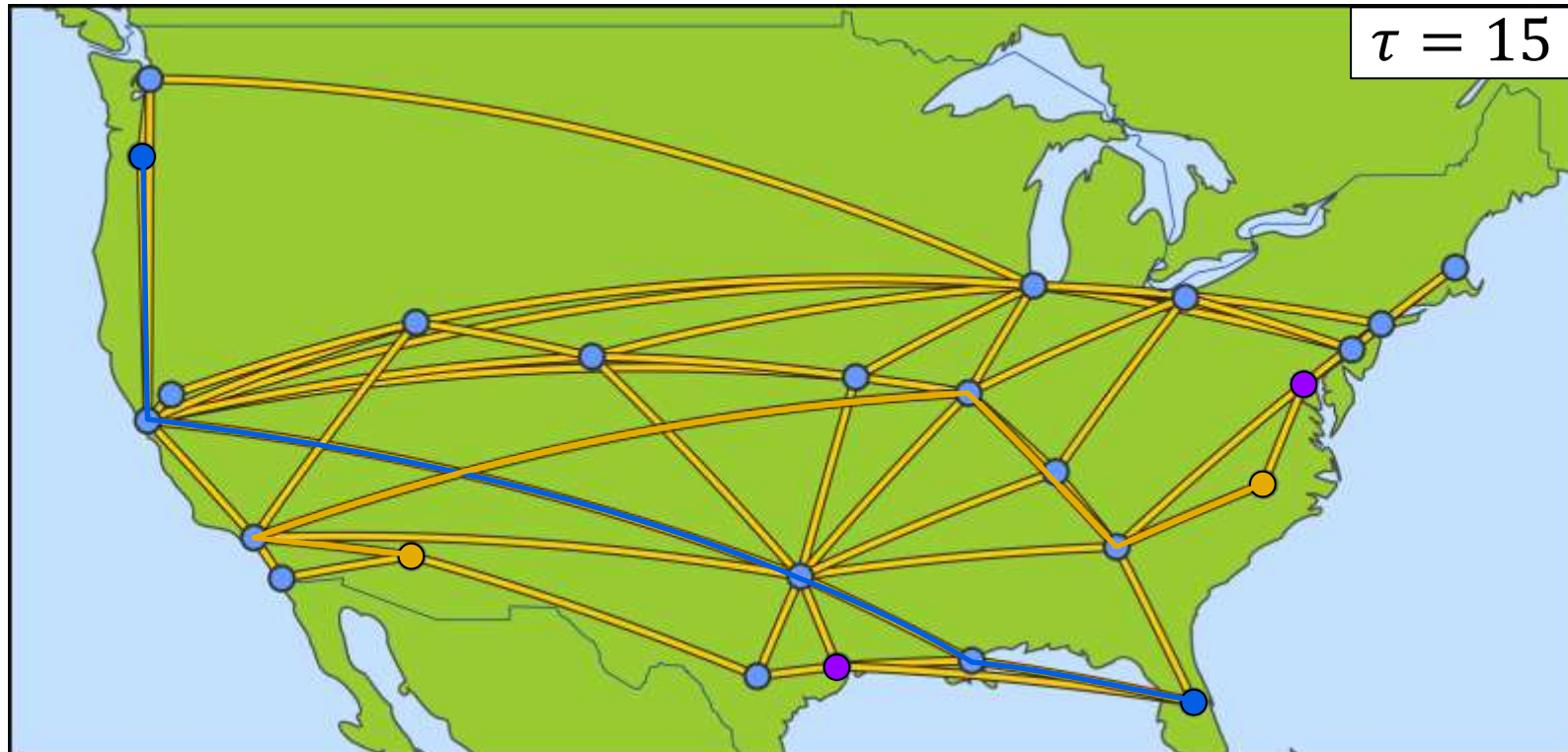

# Example: dynamic flow allocation in SDN network

- **Service:** provide a connection between two nodes when demanded
- **Objective:** minimize number of used links

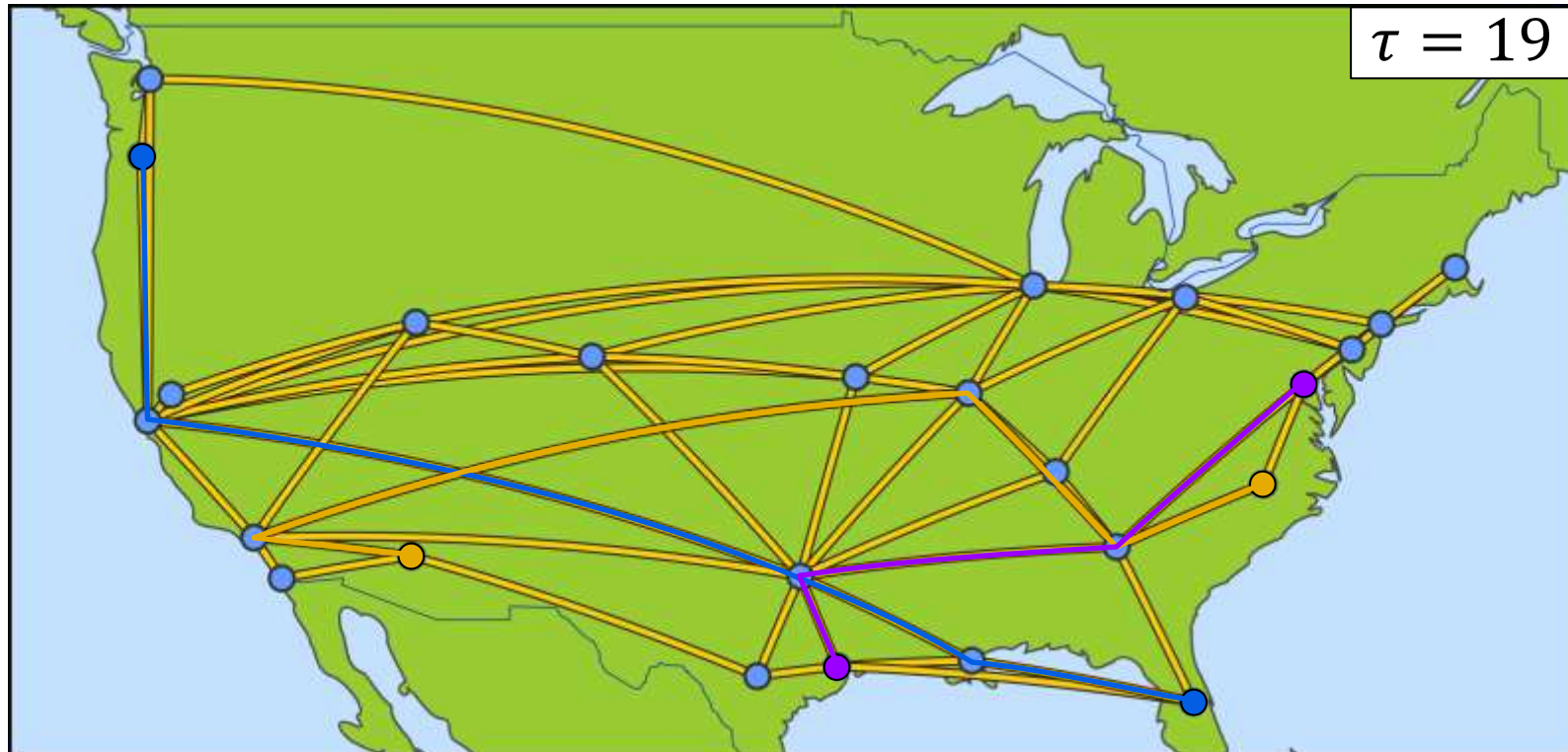

# Example: evaluating adaptation algorithms

- Operator uses a **genetic algorithm** to find a near-optimal integer path
- Possible **initial populations**:  $\mathbf{p} = \{250, 750, 1250, 1750, 2250, 2750\}$
- Which initial population values lead to **profitable** networks?

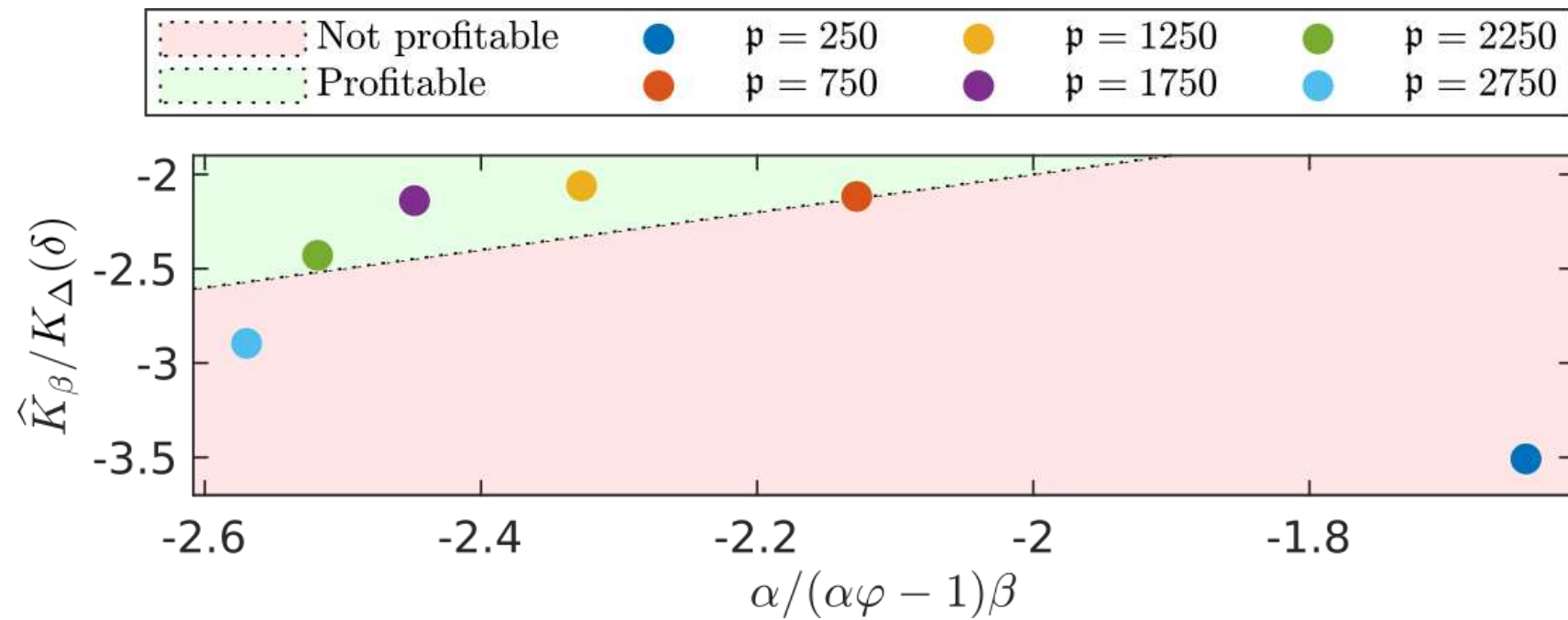

# And what about complexity?

- Softwarization vastly increases the degree of freedom  
→ complexity increases, amount of data increases
- **Artificial Intelligence (AI)** in future networks can help to solve optimization problems better

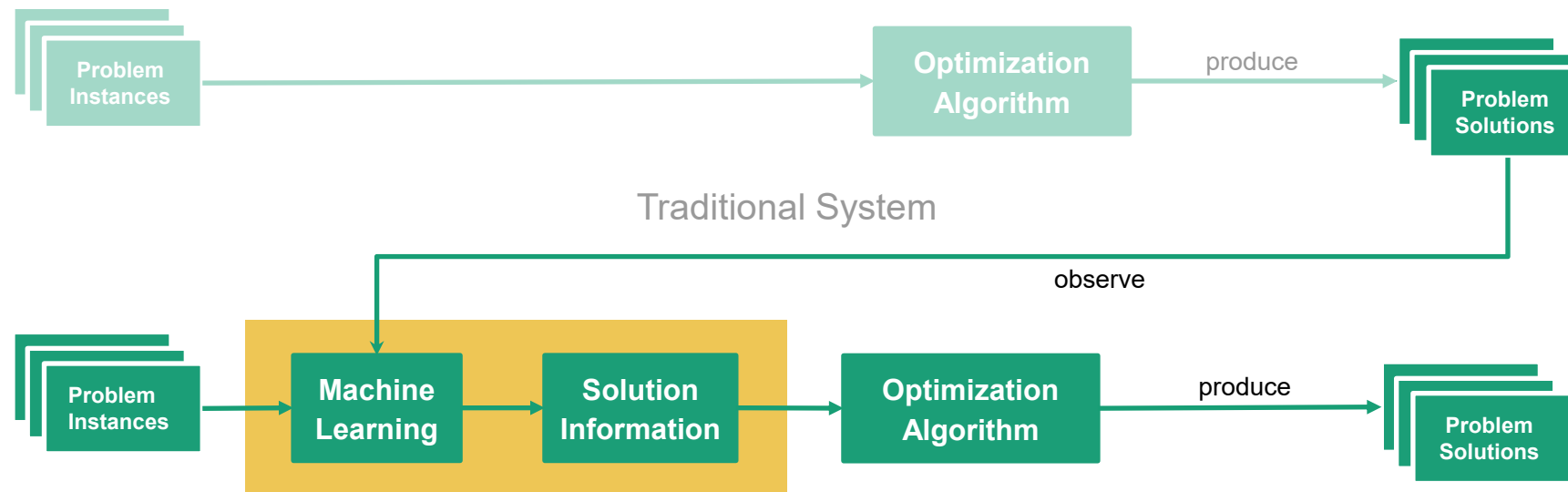

# How can we boost the solving of the related optimization problems (leaving your algorithms untouched)?

- NeuroViNE:

Hopfield neural network to preprocess (subgraph extraction) VNE algorithms - tailored filtering

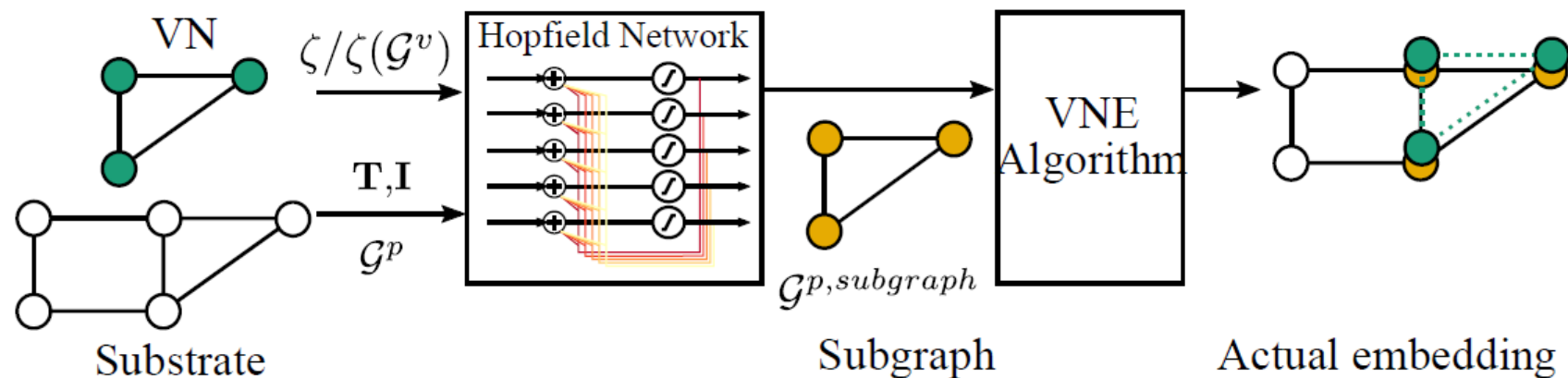

- Idea: Extract subgraph with physical **nodes close to each other** and **high available capacities**

# NeuroViNE: Efficiency on Real Network Topologies

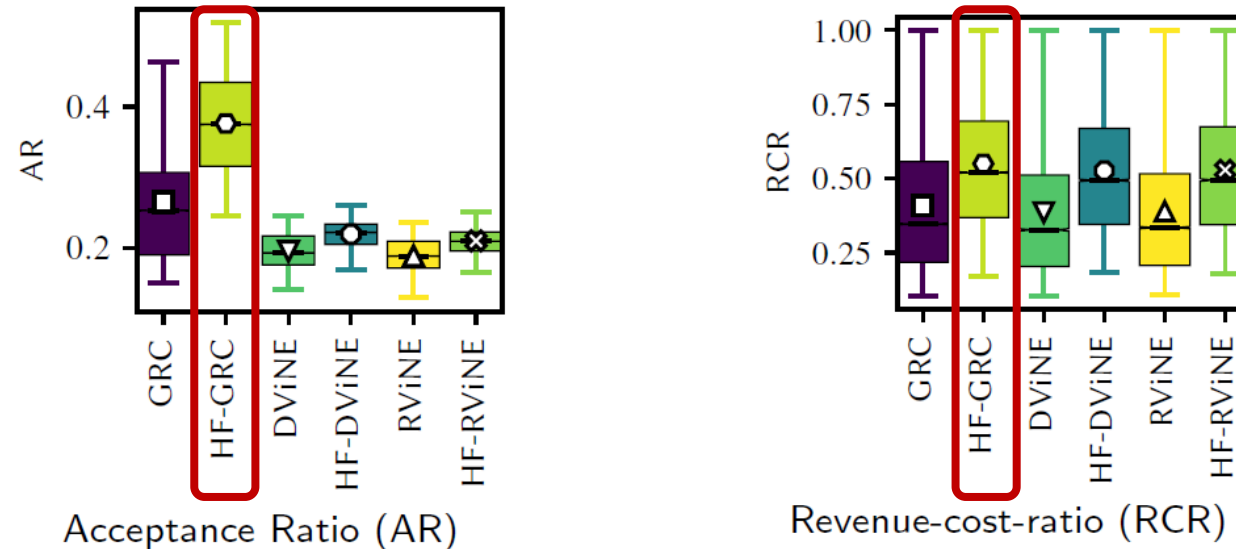

- VNE algorithms (GRC, DViNE, RViNE) vs. Hopfield variants (HF-GRC, HF-DViNE, HF-RViNE)
- NeuroViNE accepts more networks with less costs

# Towards Autonomous Networks

- Network Managers' all-time Dream:  
*lean back and watch!*

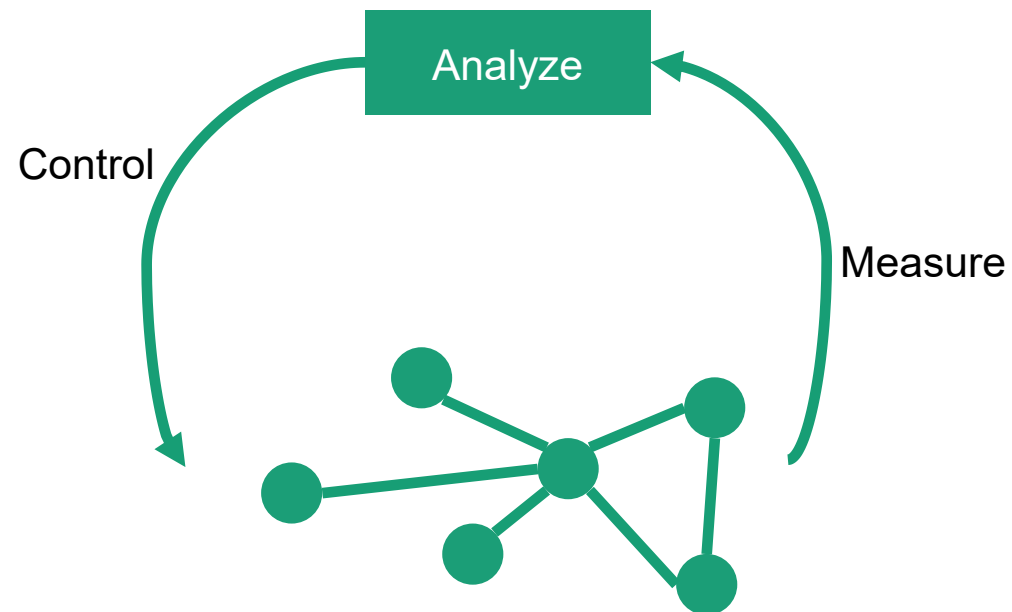

# Digital Twins

- Network Digital Twin = synchronized copy of a system (component)
- DTs may interact in simulation space
- DTs may get information from DTs representing the environment / channel (sensors, trajectories)
- DTs simulate system behavior to improve the system
- Input to simulation: (autonomous) benchmarking

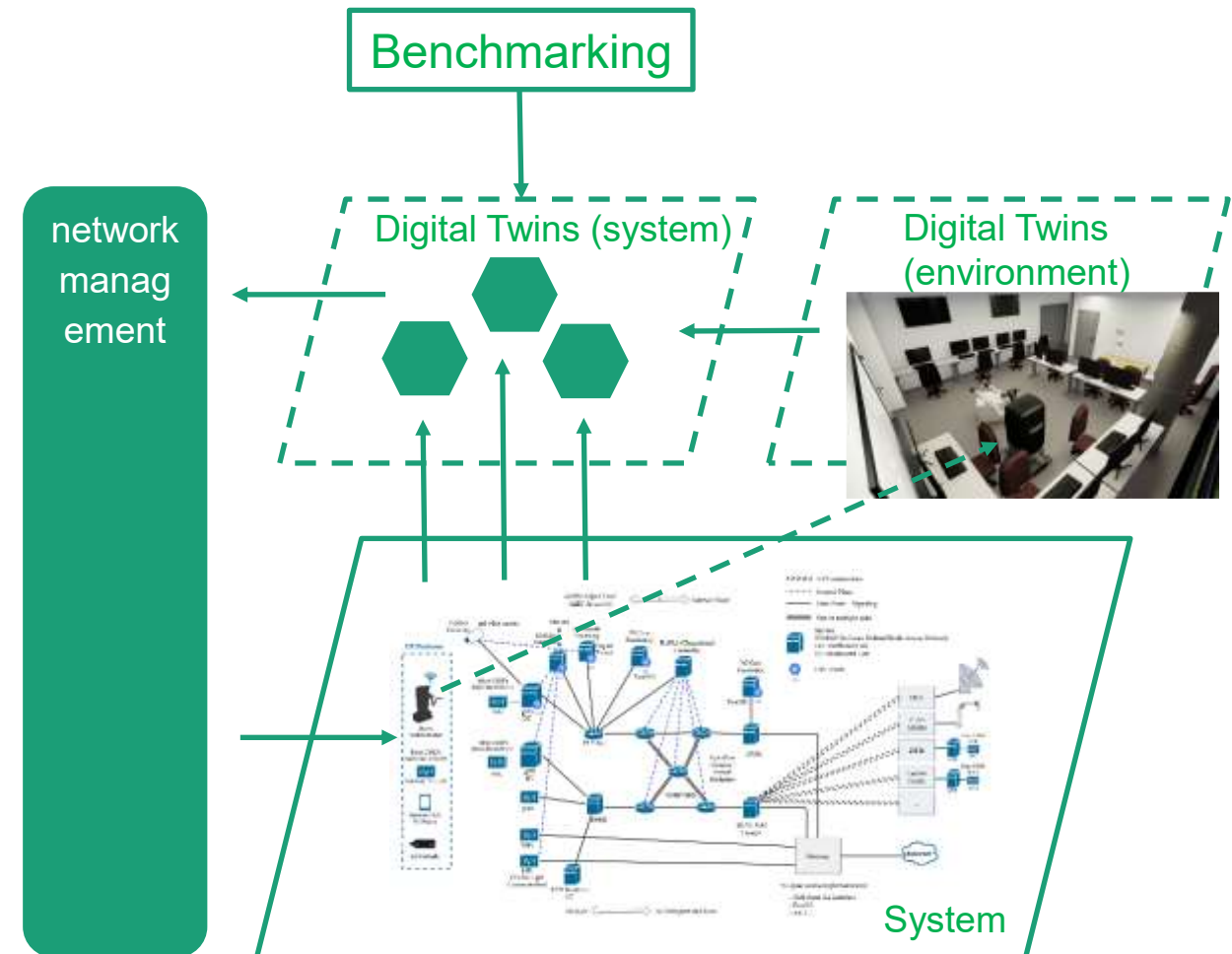



# KAPETĀNIOS: Automated Kubernetes Adaptation through a Digital Twin

## Concept

- self-operating **Kubernetes (K8s)** cluster
- uses **digital twinning** and **machine learning** to
- **autonomously adapt** its Horizontal Pod Autoscaler (HPA) to workload changes

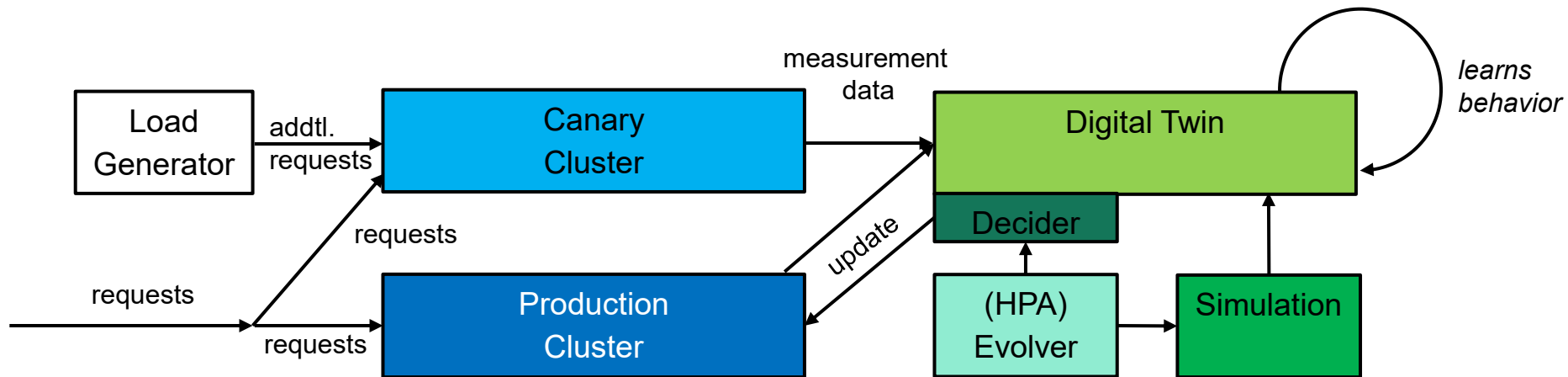

# KAPETĀNIOS: Automated Kubernetes Adaptation through a Digital Twin

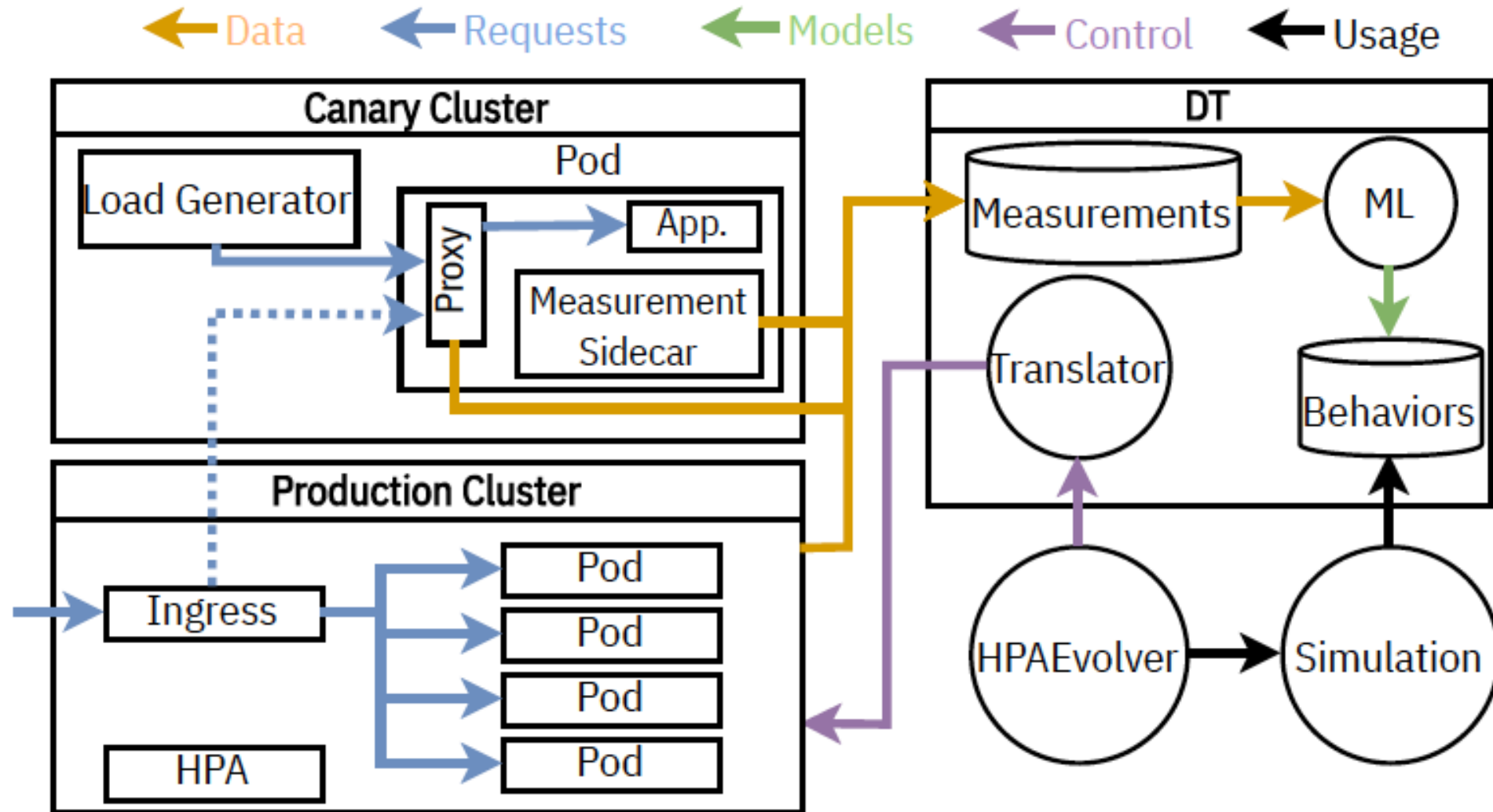

# KAPETÁNIOS: Automated Kubernetes Adaptation through a Digital Twin

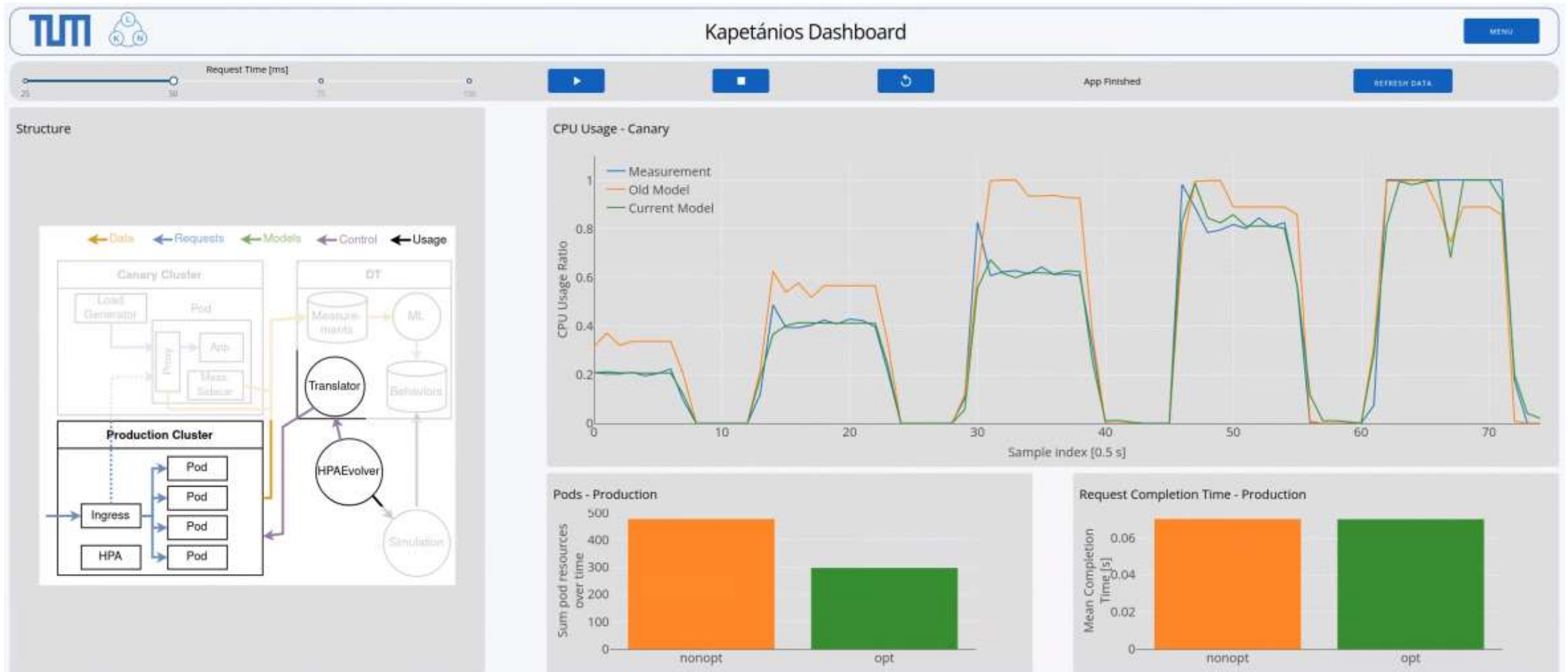

# Summary

- 6G clearly builds on a strong multi-network paradigm and addresses future networking
- New requirements demand for new networking and network management concepts on top of in-network computing and network programmability
  - Flexibility & adaptation: consider cost
  - AI-driven networking
  - Digital Twins
  - Autonomous benchmarking
  - Autonomous networking



Gefördert durch

Bayerisches Staatsministerium für  
Wirtschaft, Landesentwicklung und Energie



This work receives financial support by the Federal Ministry of Education and Research of Germany (BMBWF) in the programme of "Souverän. Digital. Vernetzt." joint project 6G-life, project identification number 16KISK002, and the Bavarian Ministry of Economic Affairs, Regional Development and Energy as part of the project "6G Future Lab Bavaria" and "5G Testbed" and "6G und Quantentechnologie", and the German Research Foundation (DFG), grant numbers: 316878574, 438892507, 315177489.

# References

- Martínez Alba, Alberto; Babarczi, Péter; Blenk, Andreas; He, Mu; Krämer, Patrick; Zerwas, Johannes; Kellerer, Wolfgang: Modeling the Cost of Flexibility in Communication Networks. IEEE INFOCOM 2021 - IEEE Conference on Computer Communications, 2020.
- Van Bemten, Amaury; Deric, Nemanja; Varasteh, Amir; Schmid, Stefan; Mas Machuca, Carmen; Blenk, Andreas; Kellerer, Wolfgang: Chameleon: Predictable Latency and High Utilization with Queue-Aware and Adaptive Source Routing. 16th International Conference on emerging Networking EXperiments and Technologies (CoNEXT), 2020.
- Kellerer, Wolfgang; Kalmbach, Patrick; Blenk, Andreas; Basta, Arsany; Reisslein, Martin; Schmid, Stefan: Adaptable and Data-Driven Softwarized Networks: Review, Opportunities, and Challenges. Proceedings of the IEEE **107** (4), 2019, 711 – 731.
- Ayan, Onur; Vilgelm, Mikhail; Klügel, Markus; Hirche, Sandra; Kellerer Wolfgang: Age-of-Information vs. Value-of-Information Scheduling for Cellular Networked Control Systems. ACM/IEEE International Conference on Cyber-Physical Systems, ACM/IEEE, 2019 ICCPS'19.
- Ayan, Onur; Ephremides, Anthony; Kellerer, Wolfgang: Age of Information: An Indirect Way To Improve Control System Performance. INFOCOM: Age of Information Workshop, 2021.
- Zerwas, Johannes; Kalmbach, Patrick; Henkel, Laurenz; Retvari, Gabor; Kellerer, Wolfgang; Blenk, Andreas; Schmid, Stefan: NetBOA: Self-Driving Network Benchmarking. ACM SIGCOMM 2019 Workshop on Network Meets AI & ML (NetAI '19), 2019

Thank you

<https://6g-life.de>

<https://www.6g-future-lab.de/>

<https://www.5g-munich.de>

[https://corp.mobile.rakuten.co.jp/english/news/press/2022/0420\\_01/](https://corp.mobile.rakuten.co.jp/english/news/press/2022/0420_01/)





Gefördert durch

Bayerisches Staatsministerium für  
Wirtschaft, Landesentwicklung und Energie

